

FORI ESAGONALI
M5 DIAM.7,2MM

FORI ESAGONALI
M5 DIAM.7,2MM

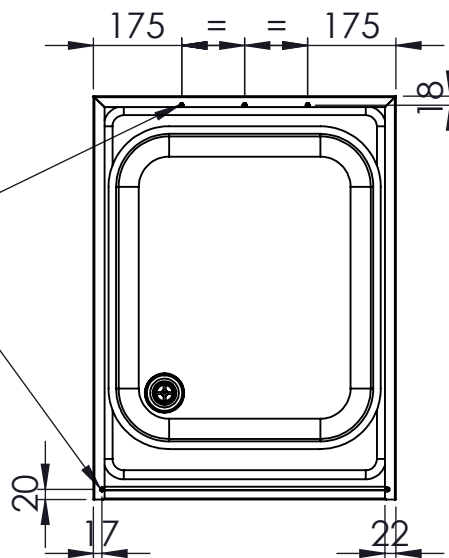

DISEGNATO	
DATA	10/01/2024
PESO	11719.82

CODICE: **LW00**



CONFIGURAZIONE: **L:600 P:800**

SCALA:1:15

A4

FOGLIO 1 DI 1